

AOC



LCD Monitor User Manual 16T2

Safety.....	3
National Conventions.....	3
Installation.....	4
Cleaning.....	5
Maintenance	6
Other.....	6
Setup	7
Contents in Box	7
Adjusting Viewing Angle.....	8
Wall Mounting	9
Connecting the Monitor.....	10
Multi-Touch Screen	11
Adjusting.....	12
Hotkeys.....	12
Type C function working status for charge:.....	14
OSD Setting.....	15
Driver	17
i-Menu.....	17
e-Saver	18
Screen+	19
Troubleshoot.....	20
Specification.....	21
General Specification.....	21
Preset Display Modes.....	24
Plug and Play.....	25

Safety

National Conventions

The following subsections describe notational conventions used in this document.

Notes, Cautions, and Warnings

Throughout this guide, blocks of text may be accompanied by an icon and printed in bold type or in italic type. These blocks are notes, cautions, and warnings, and they are used as follows:



NOTE: A NOTE indicates important information that helps you make better use of your computer system.



CAUTION: A CAUTION indicates either potential damage to hardware or loss of data and tells you how to avoid the problem.



WARNING: A WARNING indicates the potential for bodily harm and tells you how to avoid the problem. Some warnings may appear in alternate formats and may be unaccompanied by an icon. In such cases, the specific presentation of the warning is mandated by regulatory authority.



WARNING: This product contains magnets. Please keep it away from objects that may be affected by a magnet, such as pacemaker.



WARNING:

This product contains rechargeable lithium battery:

Incorrect replacement of battery type can defeat safeguard of the monitor.

Disposal of the battery into fire or a hot oven, or mechanically crushing or cutting of the battery can result in an explosion.

Leaving the battery in an extremely high-temperature surrounding environment can result in an explosion or leakage of flammable liquid or gas.

A battery subjected to extremely low air pressure may result in an explosion or leakage of flammable liquid or gas.

Installation

! Do not place the monitor on an unstable cart, stand, tripod, bracket, or table. If the monitor falls, it can injure a person and cause serious damage to this product. Use only a cart, stand, tripod, bracket, or table recommended by the manufacturer or sold with this product. Follow the manufacturer's instructions when installing the product and use mounting accessories recommended by the manufacturer. A product and cart combination should be moved with care.

! Never push any object into the slot on the monitor cabinet. It could damage circuit parts causing a fire or electric shock. Never spill liquids on the monitor.

! Do not place the front of the product on the floor.

! Leave some space around the monitor as shown below. Otherwise, air-circulation may be inadequate hence overheating may cause a fire or damage to the monitor.

See below the recommended ventilation areas around the monitor when the monitor is installed with the stand:

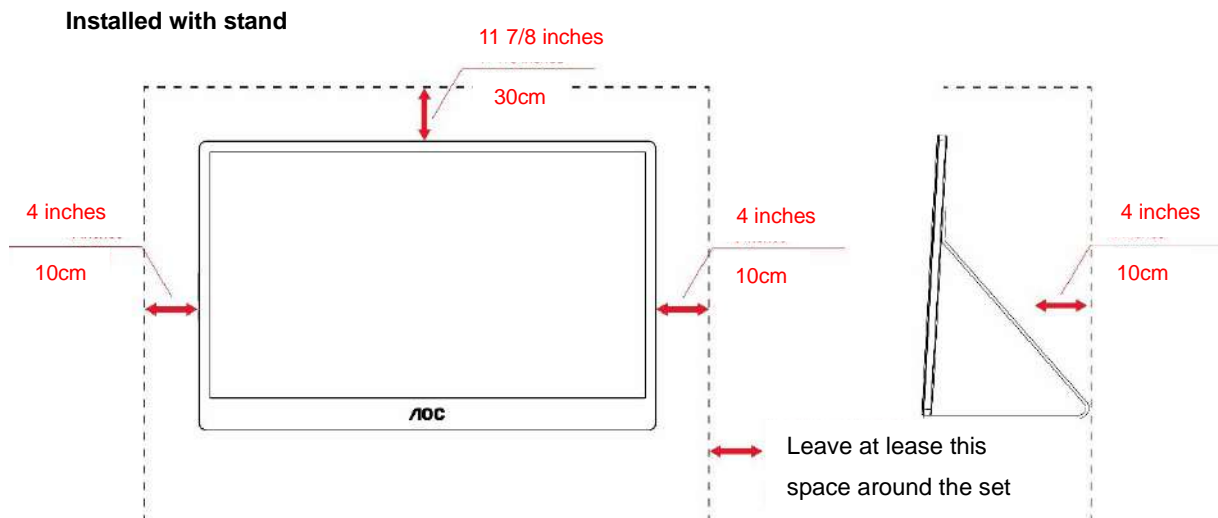

Cleaning

! Clean the cabinet regularly with cloth. You can use soft-detergent to wipe out the stain, instead of strong-detergent which will cauterize the product cabinet.

! When cleaning, make sure no detergent is leaked into the product. The cleaning cloth should not be too rough as it will scratch the screen surface.

! Please disconnect the power cord before cleaning the product.



Maintenance

- To protect your monitor from possible damage, do not put excessive pressure on the LCD panel. When moving your monitor, grasp the frame to lift; do not lift the monitor by placing your hand or fingers on the LCD panel.
- Unplug the monitor if you are not going to use it for an extensive period of time.
- Unplug the monitor if you need to clean it with a slightly damp cloth. The screen may be wiped with a dry cloth when the power is off. However, never use organic solvent, such as, alcohol, or ammonia-based liquids to clean your monitor.
- To avoid the risk of shock or permanent damage to the set, do not expose the monitor to dust, rain, water, or excessive moisture environment.
- If your monitor gets wet, wipe it with dry cloth as soon as possible.
- If foreign substance or water gets in your monitor, please turn the power off immediately and disconnect the power cord. Then, remove the foreign substance or water, and send it to the maintenance center.
- Do not store or use the monitor in locations exposed to heat, direct sunlight or extreme cold.
- After the product being repaired restore it to normal operating conditions by plugging it.
- In order to maintain the best performance of your monitor and use it for a longer lifetime, please use the monitor in a location that falls within the following temperature and humidity ranges.

Temperature: 0-40°C 32-104°F

Humidity: 20-80% RH

Other

 If the product is emitting a strange smell, sound or smoke, disconnect the power plug IMMEDIATELY and contact a Service Center.

 Make sure that the ventilating openings are not blocked by a table or curtain.

 Do not engage the LCD monitor in severe vibration or high impact conditions during operation.

 Do not knock or drop the monitor during operation or transportation.

 For display with glossy bezel the user should consider the placement of the display as the bezel may cause disturbing reflections from surrounding light and bright surfaces.

 Keep your monitor away from sharp objects.

Setup

Contents in Box



Monitor

*

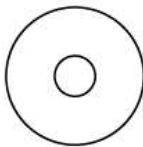

CD Manual



Smart Cover



USB C-C/A cable *

*



Micro HDMI-HDMI cable

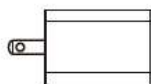

Power Adapter

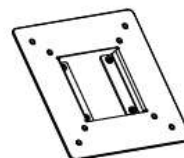

VESA_bracke



Screw

* Different according to region.

* USB-C has various different specifications. Before purchasing the AOC 16T2 USB-C Monitor, please confirm that your device's USB-C port has support for "DP Alt Mode".

This is essential for the monitor to receive video from your device via USB-C cable.

Adjusting Viewing Angle

For optimal viewing, it is recommended to look at the full face of the monitor, and then adjust the monitor's angle to your own preference.

Hold the Smart Cover and Monitor so you will not topple the monitor when you change the monitor's angle.

You are able to adjust the monitor's angle from 20° to 30° (Horizontal) or from 25° to 30° (longitudinal).



NOTE:

1. Do not adjust the viewing angle over 20~30 degrees (Horizontal) or 25~30 degrees (longitudinal) in order to avoid damage.
2. Hold the Smart Cover and Monitor so you will not topple the monitor when you change the monitor's angle.
3. Do not touch the LCD screen when you change the angle. It may cause damage or break the LCD screen.

AOC 16T2 monitor supports an auto-pivot function to keep the display upright as the monitor is rotated between portrait and landscape position.

Important: Install I-MENU (Version 2.0 or upper) from CD-ROM or AOC website.

The OSD menu can be switched along with the rotation of the display. i-Menu is required for rotating the display content along with the rotation of the display. i-Menu is for Windows only.

Wall Mounting

Preparing to Install An Optional Wall Mounting Arm.

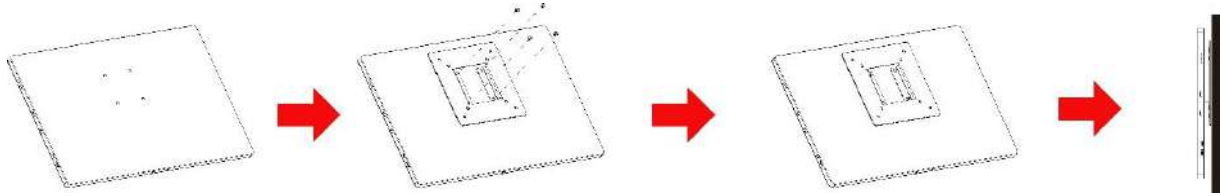

This monitor can be attached to a wall mounting arm you purchase separately. Disconnect power before this procedure. Follow these steps:

- 1 Attach the VESA_bracket lock to the back of monitor with 4 screws.
- 2 Follow the manufacturer's instructions to assemble the wall mounting arm.
- 3 Place the wall mounting arm onto the VESA_bracket. Line up the holes of the arm with the holes in the VESA_bracket.
- 4 Insert the 4 screws into the holes and tighten.
- 5 Reconnect the cables. Refer to the user's manual that came with the optional wall mounting arm for instructions on attaching it to the wall.

NOTE: VESA mounting screw holes are not available for all models, please check with the dealer or official department of AOC.

Connecting the Monitor

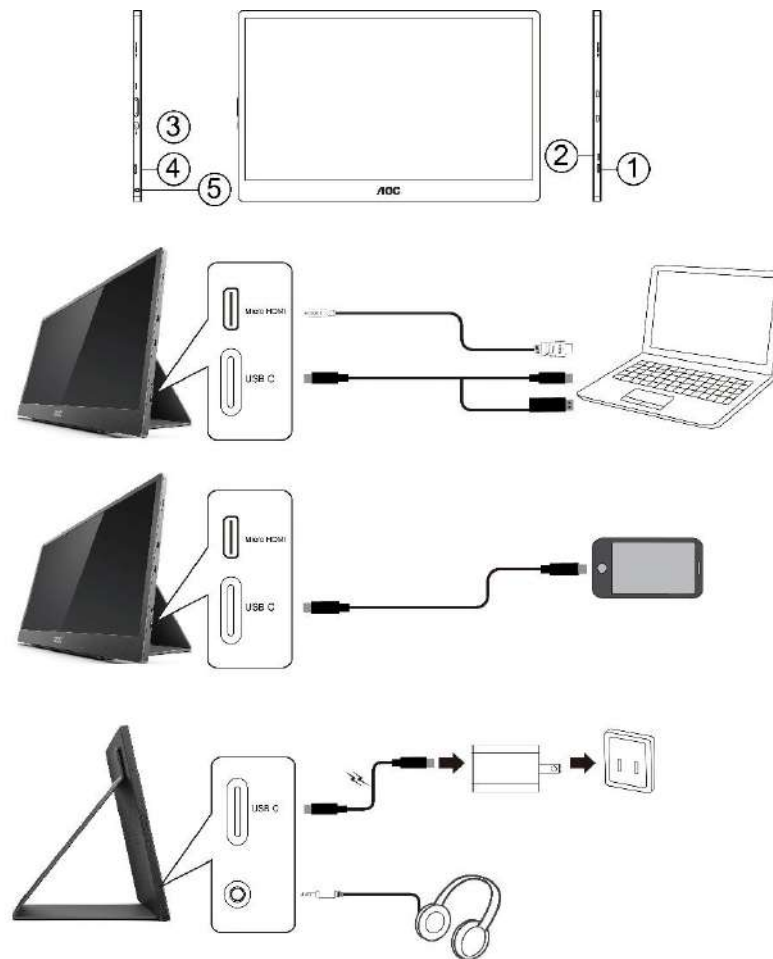

- 1 USB C
- 2 Micro HDMI
- 3 Power Button
- 4 USB C
- 5 Audio out

To protect equipment, always turn off the PC and LCD monitor before connecting.

1. Connect one end of the USB C-C/A signal cable to the USB C interface of LCD. Connect the other end to the USB C interface of computer (DP Alt mode supported), mobile device or USB A interface.
2. Your computer should detect the USB Monitor automatically.
3. Connect one end of the Micro HDMI-HDMI signal cable to the Micro HDMI interface of LCD and the other end to the HDMI interface of computer.
4. (Optional –Requires a video card with Audio port) – Connect the headphone to the headphone interface on the side of the display.
- 6 Used USB C-C cable to do battery charging: Plug one end of the USB C-C signal cable fully into the power adapter to ensure safety. Plug the other to the USB C interface of LCD.
- 7 Type C cable with Type A for touch function when user use HDMI input.

If your monitor displays an image, installation is complete. If it does not display an image, please refer to Troubleshooting.

Multi-Touch Screen

User can use Display Multi-touch Function under operating system higher than Window 7 home premium. Before using Display Multi-touch Function, user need to connect basic wires (power cable, HDMI cable, USB cable). Then user can fully enjoy Multi-touch Function. Part of specific use, please see the following drawings.

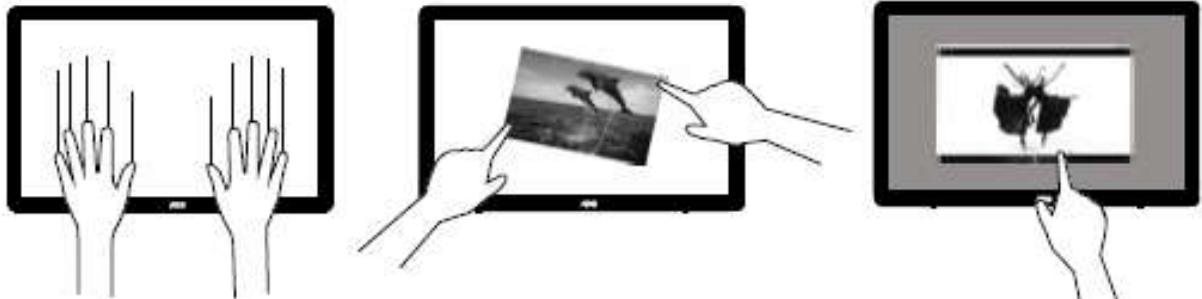

Adjusting

Hotkeys

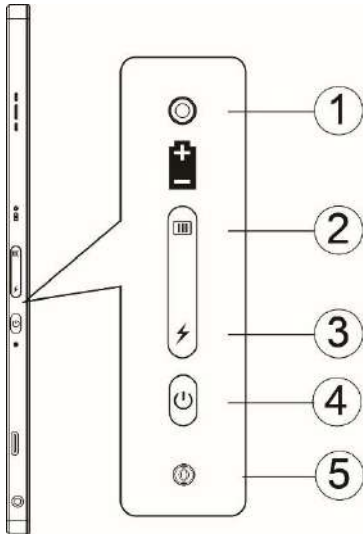

1	Battery indicator light
2	Menu/Volume/Increase
3	Battery capacity display
4	Power on/off
5	Power indicator light

Battery indicator light

Battery capacity 0%~5% show red color.

Battery capacity 5%~50% show orange color.

Battery capacity 50%~75% show yellow color.

Battery capacity 75%~100% show green color.

Menu/Volume/Increase

Press to display the OSD.

When Power on, press  button to display OSD or adjust OSD function (0~100 or OD strength adjustment, etc.).

When there is no OSD, press  button continuously about 3 seconds to turn on the volume adjustment.

Power

Press the Power button about 3 seconds to turn on/off the monitor.

battery capacity display

When there is no OSD, Press  button to show the battery capacity.

Press  button and hold for 3 seconds, It allows external devices to charge 16T2 or 16T2 to charge external devices (Mobile and Tablet only).

LED status indicator

Power on - white.

Standby - white flashes and goes out after about 3 minutes.

Charging - orange.

Charge your phone/tablet

When 16T2 is switched on, the phone/tablet is connected and the signal indicator shows an orange light. Press the battery power button for 3~5 seconds, the power light appears white and starts charging (you can observe whether the phone has been charged from the mobile phone, then the screen of power mode switch will be reconnected, and the flash is normal).

When 16T2 is turned off, connect to the phone/tablet and the power light will appear orange. Press the battery power button for 3 to 5 seconds and the power light will appear white and start charging (you can observe whether the phone is charged or not from the phone).



WARNING: 16T2 default is the state of being charged, reverse to the mobile phone charging will have compatibility problems not fully support all mobile phones.

Type C function working status for charge:

Charging status: (Type C 1=TC1, Type C 2=TC2)

TC1 and TC2 support PD adaptor CC profile 5V/3A input.

When TC 1 and TC 2 both are insert adaptor that will select one port to charge who is first insert.

TC 1(TC 2) insert adaptor and TC 2 (TC 1) connection to mobile phone or tablet, the status will be monitor and mobile phone or tablet both are charged.

When (TC1 or TC2) insert adaptor and another side (TC1 or TC2) connector mobile phone or tablet that will output 5V/500mA (maximum) to charging mobile phone or tablet.

Ps. 1.support Notebook to monitor charging, not support monitor to Notebook charging.

2.Charge phone or tablet need push battery voltage display key 3~5 second switch on charge function.

TC1/TC2	Adaptor	Phone/Tablet	NB	NA
Adaptor	Plug & Play System charging	TC1 Signal and System charging TC2 System charging	TC1 Signal/System charging TC2 System charging	TC2 System charging
Phone/Tablet	TC1 System charging TC2 Signal/Charging	TC1/TC2 Signal and System charging	TC1 Signal/System charging TC2 Signal and System charging	TC2 Signal and System charging
NB	TC1 System charging TC2 Signal/System Charging	TC1 Signal and System charging TC2 Signal/System charging	TC1 Signal/System charging TC2 Signal/System charging	TC2 Signal and System charging
NA	TC1 System charging	TC1 Signal and System charging	TC1 Signal/System charging	NA

Power bank mode:

When push ⚡ long time (3~5 second) and connection the phone/tablet

TC1 and TC2 output 5V/500mA(maximum)



WARNING: 16T2 default is the state of being charged, reverse to the mobile phone charging will have compatibility problems not fully support all mobile phones.

Suggest to charge the mobile phone in DC ON state.

Push battery voltage display once will show battery status on LED.

Battery capacity 0%~5% show RED color.

Battery capacity 5%~50% show ORANGE color.

Battery capacity 50%~75% show YELLOW color.

Battery capacity 75%~100% show GREEN color.

Power bank mode only support Type C USB C PD device.

NOTE: 16T2 needs to be charged for 8 hours when first time use. Normally charging with accessory adaptor for 5 to 6 hours can reach its full capacity.











OSD Setting

Basic and simple instruction on the control keys.



1). Press the  key to activate the OSD window.

2). You can now select any one of the functions by quickly repeat-pressing the  button. The cursor will navigate towards the right as you press the key. You can release once the cursor highlights the option you want to choose. Note that the selection is one way loop always moving one direction and then returning at beginning of the menu. The cursor will remain on the selected function for about 3 seconds and the function icon will flash three times to confirm the choice visible on the 1st layer of the OSD and activate it.

Input source			Select input source: HDMI
			Select input source: USB C1
			Select input source: USB C2
Brightness		0-100	Adjust brightness from 0~100
Contrast		0-100	Adjust contrast from 0~100
Volume		0-100	Adjust Volume from 0~100
Overdrive		Off	Adjust the response time.
		Weak	
		Medium	
		Strong	
LowBlue Mode		Off	Decrease blue light wave by controlling color temperature
		Multimedia	
		Internet	
		Office	
		Reading	
HDR Mode		Off	Adjust contrast HDR Mode
		HDR Picture	
		HDR Movie	
		HDR Game	
Language		English, Français, Español, Português, Deutsch, Italiano, Nederlands, Svenska, Suomi, Polski, Čeština, Русский, 한국어, Türkçe, 繁體中文, 简体中文, 日本語.	Select the OSD language Default is English.

Exit		Exit the main OSD
------	---	-------------------

1. Main menu will disappear if no action for about 3 seconds..
2. Sub menu will disappear if no action for about 3 seconds..
3. Before entering OSD menu,monitor will be powered off when continually pressing the  button key for more than 3 seconds.
4. The input source selection does not display the current input source.

Driver

i-Menu



Welcome to "i-Menu" software by AOC. i-Menu makes it easy to adjust your monitor display setting by using on screen menus instead of the OSD button on the monitor. To complete installation, please follow the installation guide.

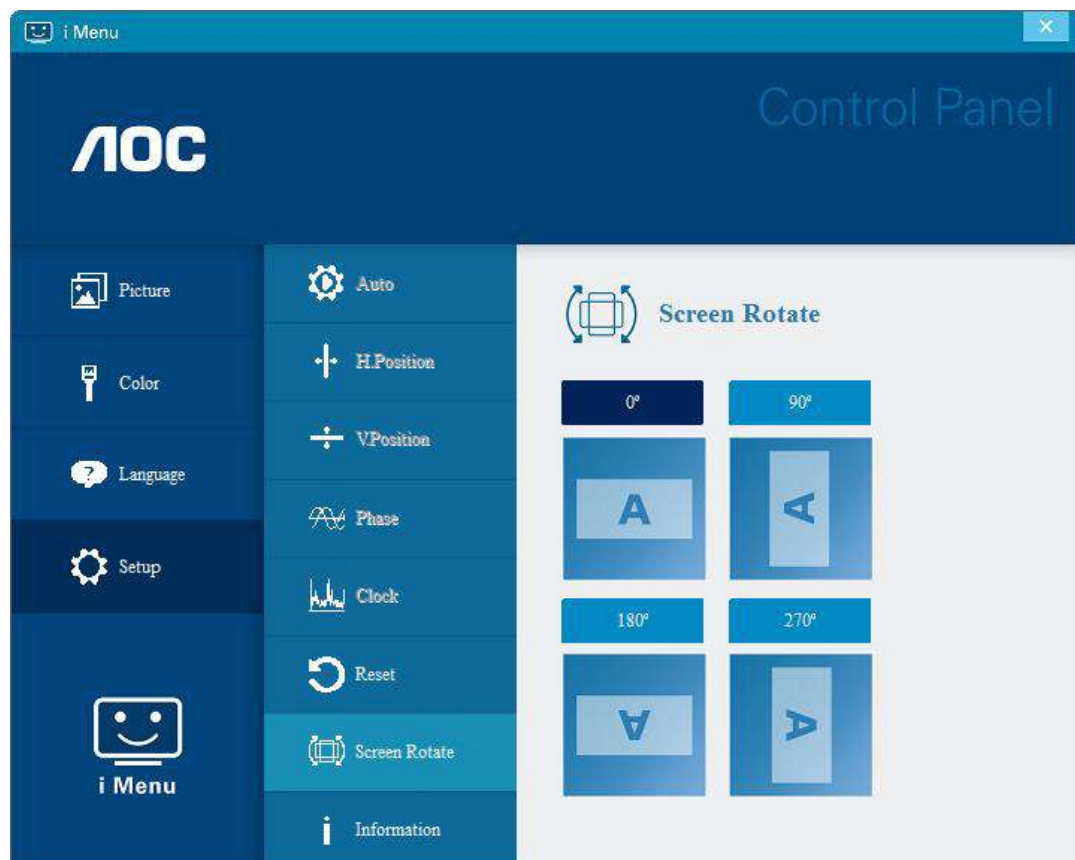

e-Saver



Welcome to use AOC e-Saver monitor power management software! The AOC e-Saver features Smart Shutdown functions for your monitors, allows your monitor to timely shutdown when PC unit is at any status (On, Off, Sleep or Screen Saver); the actual shutdown time depends on your preferences (see example below).

Please click on "driver/e-Saver/setup.exe" to start installing the e-Saver software, follow the install wizard to complete software installation.

Under each of the four PC status, you may choose from the pull-down menu the desired time (in minutes) you're your monitor to automatically shut down. The example above illustrated:

- 1) The monitor will never shutdown when the PC is powered on.
- 2) The monitor will automatically shutdown 5 minutes after the PC is powered off.
- 3) The monitor will automatically shutdown 10 minutes after the PC is in sleep/stand-by mode.
- 4) The monitor will automatically shutdown 20 minutes after the screen saver appears.

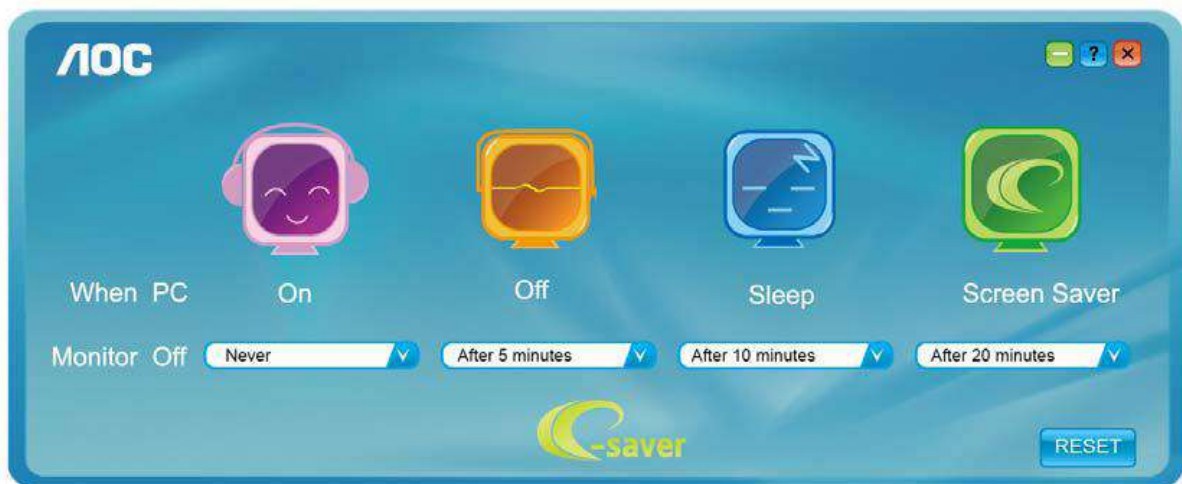

You can click "RESET" to set the e-Saver to its default settings like below.

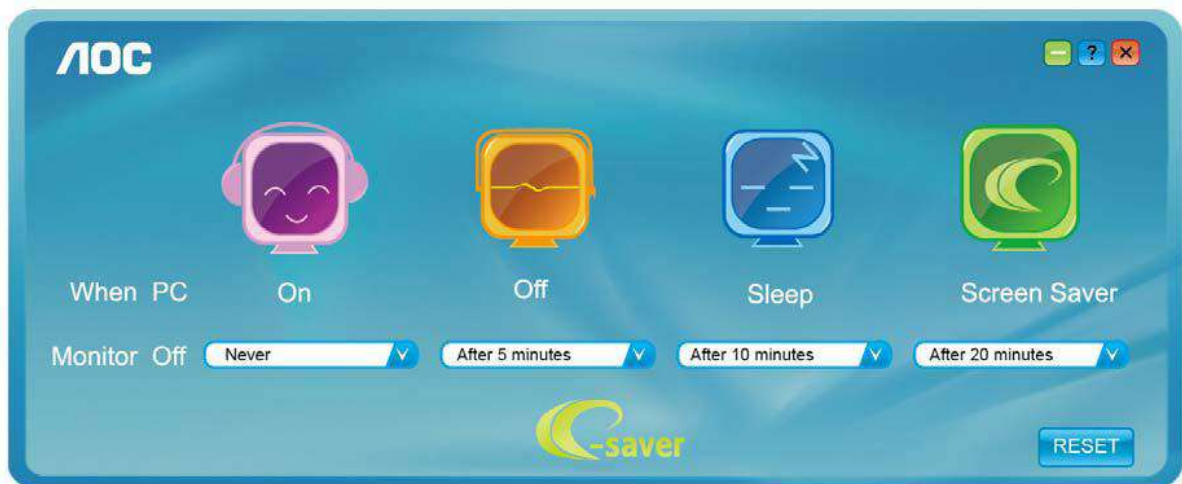

Screen+



Welcome to “Screen+” software by AOC. Screen+ software is a desktop screen splitting tool; it splits the desktop into different panels, and each panel displays a different window. You only need to drag the window to a corresponding panel when you want to access it. It supports multiple monitor display to make your task easier. Please follow the installation software to install it. The software Supported operating systems: Windows 10, Windows 8, Windows 7.

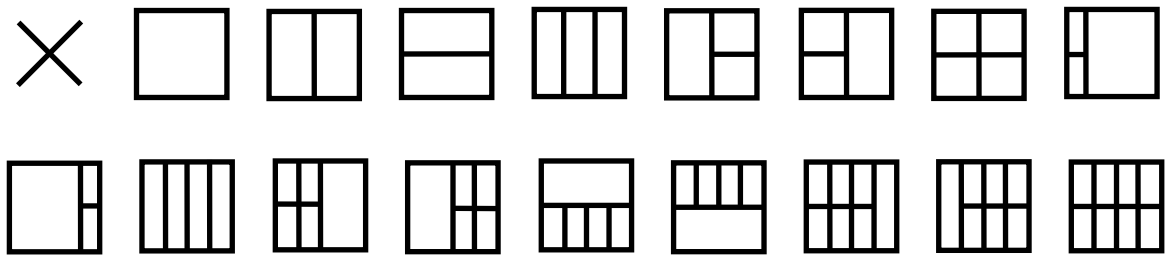

Troubleshoot

This section provides tips for correcting problems, should any occur. It also describes how to contact AOC should you encounter problems that you cannot resolve. Before you call AOC service center, please read the troubleshooting advice in this manual and in your computer User's Manual. You may also want to consult with your system administrator or company technical support staff.

Problem & Question	Possible Solutions
The monitor does not turn on	Check the connectors. Make sure the USB cable is firmly connected to the monitor Disconnect and reconnect the USB cable again. Check the condition of the USB cable. If the cable is frayed or damaged, replace the cable. If the connectors are soiled, wipe them with a clean cloth.
The screen is blank, although the computer power is on	Make sure the USB cable is properly connected the computer. Make sure the computer is on and working. The computer may be in sleep or power-saving mode, or displaying a blank screen saver. Move the mouse to "wake up" the computer.
The picture "bounces" or moves in a wave-like pattern	Move electrical devices that may cause electrical interference away from the monitor.
The monitor display does not rotate when you rotate the monitor.	Make sure the right I-MENU is properly installed.
Regulation & Service	Please refer to Regulation & Service Information which is in the CD manual or www.aoc.com (to find the model you purchase in your country and to find Regulation & Service Information in Support page).
If the notebook is connected, the 16T2 screen flashes or the charging light flashes.	Please remove the connection to the notebook and connect the Adaptor and then the notebook for light.

Specification

General Specification

Panel	Model name	16T2	
	Driving system	TFT Color LCD	
	Viewable Image Size	39.49cm diagonal	
	Pixel pitch	0.1793 (H)mm x 0.1793 (V)mm	
	Display Color	262K Colors	
	Dot Clock	148.5MHz	
Others	Horizontal scan range	30~85KHz	
	Horizontal scan Size(Maximum)	344.16 mm	
	Vertical scan range	48Hz ~ 75Hz	
	Vertical scan Size(Maximum)	193.59 mm	
	Optimal preset resolution	1920x1080@60Hz	
	Plug & Play	VESA DDC2B/CI	
	Input Connector	USB Type-C (DP Alt mode) / Micro HDMI	
	Output Connector	Earphone out	
	Power Source(input)	5Vdc, 3A	
	Power Source(output)	5Vdc, 0.5A(Maximum)	
	Power Consumption	Power on	16W
Dimensions & Weight:	Height	229.8mm	
	Width	363.4mm	
	Depth	9.9 mm	
	Weight (monitor only)	990 g	
Environmental	Temperature:	Operating	0° to 40°C
		Non-Operating	-25° to 55°C
	Humidity:	Operating	10% to 85% (non-condensing)
		Non-Operating	5% to 93% (non-condensing)
	Altitude:	Operating	0~ 5000m(0~ 16404 ft)
		Non-Operating	0~ 12192m (0~ 40000 ft)
Support OS	Windows 7		
	Windows 8		
	Windows 10		

PS: 16T2 only as a display device.

Compatible with all DP Alt mode PC or Laptop: Recommend list is as the below (16T2 DC ON status).

No.	Type	Brand Name	Model Name	2nd Display	Supports Touch	Mobile device charging
1	Smart phone	HUAWEI	Mate 20	√	√	√
2	Smart phone	HUAWEI	P30 Pro	√	√	√
3	Smart phone	HUAWEI	Mate 30 Pro	√	√	√
4	mobile phone	HUAWEI	P20	√	√	√
5	NB	DELL	Latitude 5490	√	√	
6	NB	HP	840 G5	√	√	
7	NB	HP	745 G5	√	√	
8	NB	Lenovo	ThinkPad T480s	√	√	
9	NB	Microsoft	Surface Book 2	√	√	
10	NB	Lenovo	Thinkpad X380 Yoga	√	√	
11	NB	HP	HP Shadow Genie 5 OMEN 15	√	√	
12	NB	Microsoft	Surface Laptop 3	√	√	
13	NB	Dell	Inspiron 15 7591 2-in-1	√	√	
14	NB	HP	Spectre 13-v 119tu	√	√	
15	NB	HP	OMEN 15-dh0124TX	√	√	
16	NB	Lenovo	Legion Y740	√	√	
17	DT	Apple	Mac mini (2018)(MRTT2TA/A)(HWID: 8,1)	√	√	
18	AIO	Apple	iMac 27" (2019)(MRQY2TA/A)(HWID: 19,1)	√	√	
19	AIO	Apple	iMac Pro 27" (2017)(MQ2Y2TA/A)(HWID: 1,1)	√	√	
20	AIO	Apple	iMac 27" (2017)(MNED2TA/A)(HWID: 18,3)	√	√	
21	NB	Acer	SF713-51-M707	√	√	
22	NB	ASUS	ROG SCAR III G531GW	√	√	
23	NB	ASUS	ROG G752VT-DH72	√	√	
24	NB	Dell	G3 3590	√	√	
25	NB	Dell	E7480	√	√	
26	NB	Dell	XPS 15 9560 (P56F)	√	√	
27	NB	Dell	Latitude 7300	√	√	
28	NB	Dell	E7380	√	√	
29	NB	Fujitsu	LIFEBOOK WU2/C3	√	√	
30	NB	HP	Elite Dragonfly Notebook PC (Empire)	√	√	
31	NB	HP	Spectre x360 Conve 13-w010tu	√	√	
32	DT	Intel	NUC8i7HMK	√	√	
33	NB	Lenovo	Yoga 920-13IKB 80Y7	√	√	
34	NB	Lenovo	ThinkPad X1 Yoga (2nd Gen) TP00076C	√	√	
35	NB	Lenovo	ThinkPad 13 20GJ003ETW	√	√	
36	NB	Lenovo	ThinkPad X1C 7th	√	√	
37	NB	MSI	GT72 6QD	√	√	

No.	Type	Brand Name	Model Name	2nd Display	Supports Touch	Mobile device charging
38	DT	MSI	Vortex G65	✓	✓	
39	NB	Panasonic	CF-SV78R8QP	✓	✓	
40	NB	Razer	BLADE 15.6	✓	✓	
41	mobile phone	ASUS	ROG Phone	✓	✓	✓
42	mobile phone	ASUS	ZenFone Ares(ZS572KL)	✓	✓	✓
43	mobile phone	HTC	U12+	✓	✓	✓
44	mobile phone	HUAWEI	Mate 20 X(5G)	✓	✓	✓
45	mobile phone	HUAWEI	Mate 20 Pro	✓	✓	✓
46	mobile phone	HUAWEI	P20 Pro	✓	✓	✓
47	mobile phone	HUAWEI	Mate 10 Pro	✓	✓	✓
48	mobile phone	HUAWEI	Mate 10	✓	✓	✓
49	NB	Lenovo	ThinkPad E595 20NFCTO4WW	✓	✓	
50	NB	Lenovo	ThinkPad A485	✓	✓	
51	NB	Apple	MacBook Pro 16" (2019) (MVVJ2TA/A)(HWID: 16,1)	✓		
52	NB	Apple	MacBook Pro 15" (2018) (MR962TA/A)(HWID: 15,1)	✓		
53	NB	Apple	MacBook Air 13" (2018) (MRE82TA/A)(HWID: 8,1)	✓		
54	NB	Apple	MacBook Pro 13" (2018) (MR9U2TA/A)(HWID: 15,2)	✓		
55	NB	Apple	MacBook Pro 15" (2017) (MPTR2TA/A)(HWID: 14,3)	✓		
56	NB	Apple	MacBook Pro 13" (2017) (MPXV2TA/A)(HWID: 14,2)	✓		
57	mobile phone	LG	G8S ThinQ	✓		✓
58	mobile phone	LG	V40 ThinQ	✓		✓
59	mobile phone	OnePlus	7 Pro	✓		✓
60	mobile phone	OPPO	Reno2	✓		✓
61	mobile phone	SONY	Xperia 5	✓		✓
62	mobile phone	Xiaomi (小米)	UL4U	✓		✓

Preset Display Modes

Standard	Resolution	H. Frequency (kHz)	V. Frequency (Hz)
VGA	640x480@60Hz	31.469	59.94
SVGA	800x600@56Hz	35.156	56.25
SVGA	800x600@60Hz	37.879	60.317
XGA	1024x768@60Hz	48.363	60.004
SXGA	1280x1024@60Hz	63.981	60.02
WXGA+	1440x900@60Hz	55.935	59.887
WSXGA	1680x1050@60Hz	65.29	59.954
WSXGA	1680x1050@60Hz	64.674	59.883
HD	1920x1080@60Hz	67.5	60
SXGA-	1280x960@60HZ	60	60

Plug and Play

Plug & Play DDC2B Feature

This monitor is equipped with VESA DDC2B capabilities according to the VESA DDC STANDARD. It allows the monitor to inform the host system of its identity and, depending on the level of DDC used, communicate additional information about its display capabilities.

The DDC2B is a bi-directional data channel based on the I2C protocol. The host can request EDID information over the DDC2B channel.